

Blinder ARC 220

knog.

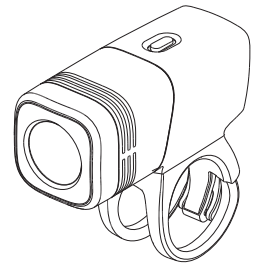

QUICKSTART GUIDE

RECHARGE BEFORE FIRST USE

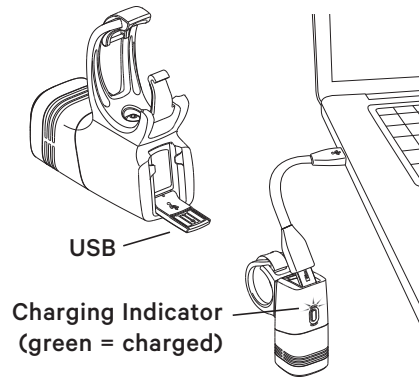

USB

Charging Indicator
(green = charged)



INTERFACE

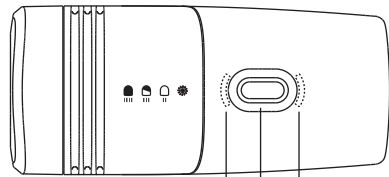

- A. Power / Mode switch
- B. Mode Indicator LED
- C. Low Battery / Charging indicator LED

Hold A for 0.75 Sec (on/off)
Press A for 0.25 Sec (mode switch)

STRAP FITMENT

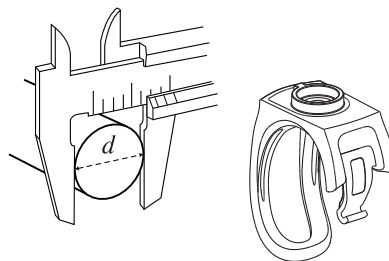

d 25 - 35mm

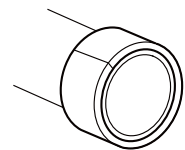

Use foam tape
for bars less
than d 25mm

ATTACHING THE STRAP

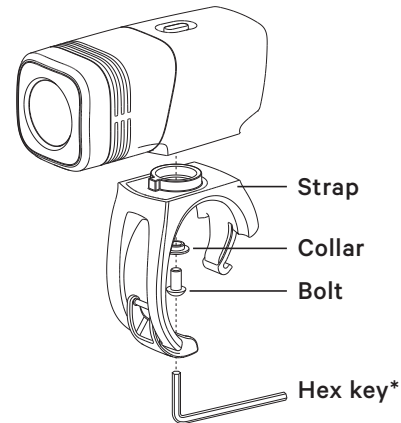

Strap

Collar

Bolt

Hex key*

Ensure bolt is firmly tightened.

*HEX KEY NOT INCLUDED

MOUNTING

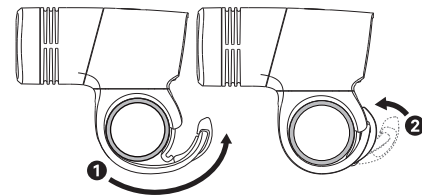

Do not rely on the metal clasp to provide strap stretch.

Ne pas compter sur le crochet en métal pour donner plus de longueur à l'attache.

No confie en la hebilla de metal para estirar la correa.

No fare affidamento sulla fibbia di metallo per fornire plu lungheza alla cinghia.

Schließen bietet keine zusätzliche Dehnung des Strap. 2-stufige Strap-Montage vermeiden.

ストラップが伸びきった状態で、金属のパックル固定を行わないようにして下さい。

CABLE CLEARANCE

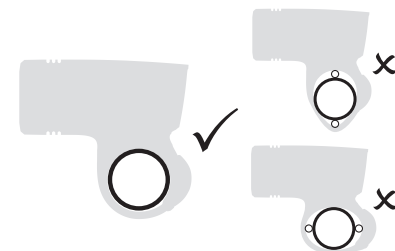

Keep clear of cables

Installez l'éclairage à l'écart des câbles

Mantenga la luz libre de cables

Keep clear of cables

Nicht über den Kabelzügen befestigen

ケーブルは避けて下さい。